

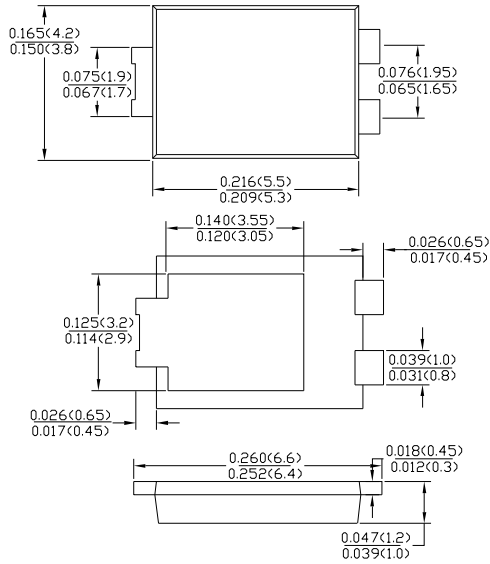

SL1045

10.0A SCHOTTKY BARRIER RECTIFIER

T0-277



Dimensions inches and (millimeters)

Features

- Schottky Barrier Chip
- High Thermal Reliability
- Patented Super Barrier Rectifier Technology
- High Forward Surge Capability
- Ultra Low Power Loss, High Efficiency
- Excellent High Temperature Stability

Mechanical Data

- Case: TO-277 Molded Plastic
- Terminals: Plated Leads Solderable per MIL-STD-202, Method 208
- Polarity: Cathode Band
- Weight: 0.093 grams (approx.)
- Mounting Position: Any
- Marking: Type Number
- Lead Free: For RoHS/Lead Free Version

Maximum Ratings and Electrical Characteristics @ $T_A=25^{\circ}\text{C}$ unless otherwise specified

Single Phase, half wave, 60Hz, resistive or inductive load.
For capacitive load, derate current by 20%.

Characteristic	Symbol	SL1045	Unit
Peak Repetitive Reverse Voltage Working Peak Reverse Voltage DC Blocking Voltage	V_{RRM} V_{RWM} V_R	45	V
RMS Reverse Voltage	$V_{R(RMS)}$	32	V
Average Rectified Output Current (Note 1) @ $T_L = 90^{\circ}\text{C}$	I_O	10.0	A
Non-Repetitive Peak Forward Surge Current 8.3ms Single half sine-wave superimposed on rated load (JEDEC Method) @ $T_L = 75^{\circ}\text{C}$	I_{FSM}	275	A
Forward Voltage Drop @ $I_F = 8\text{A}, T_J = 25^{\circ}\text{C}$ @ $I_F = 10\text{A}, T_J = 25^{\circ}\text{C}$ @ $I_F = 10\text{A}, T_J = 125^{\circ}\text{C}$	V_{FM}	0.42 0.47 0.41	V
Peak Reverse Current At Rated DC Blocking Voltage @ $V_F = 45\text{V}, T_J = 25^{\circ}\text{C}$ @ $V_F = 45\text{V}, T_J = 100^{\circ}\text{C}$ @ $V_F = 45\text{V}, T_J = 150^{\circ}\text{C}$	I_{RM}	0.3 15 75	mA
Typical Thermal Resistance Junction to Ambient (Note 2) (Note 3)	$R_{\theta JA}$	73 31	$^{\circ}\text{C}/\text{W}$
Operating Temperature Range	T_J	-55 to +150	$^{\circ}\text{C}$
Storage Temperature Range	T_{STG}	-55 to +150	$^{\circ}\text{C}$

Note: 1. Valid provided that leads are kept at ambient temperature at a distance of 9.5mm from the case.
2. FR-4 PCB, 2oz. Copper, minimum recommended pad layout .
3. Polyimide PCB, 2oz. Copper. Cathode pad dimensions 18.8mm x 14.4mm. Anode pad dimensions 5.6mm x 14.4mm.



10.0A SCHOTTKY BARRIER RECTIFIER SL1045

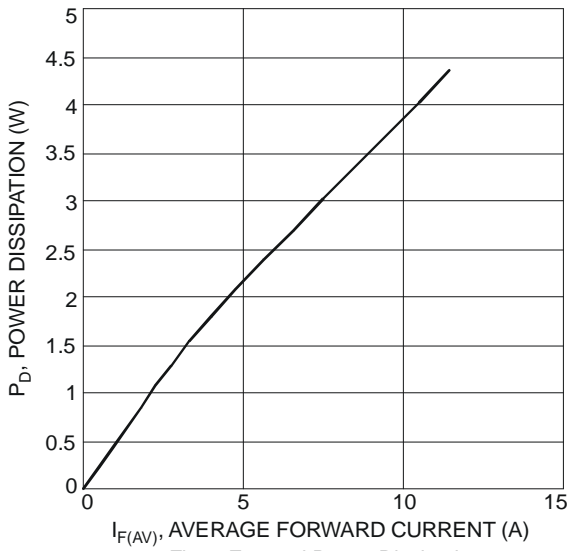

Fig. 1 Forward Power Dissipation

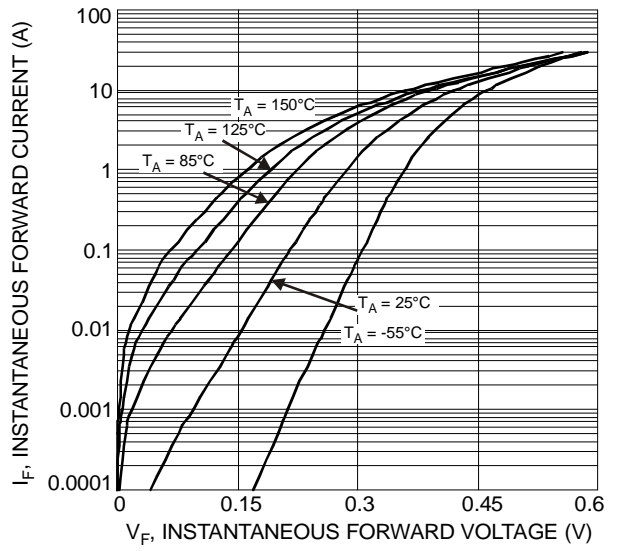

Fig. 2 Typical Forward Characteristics

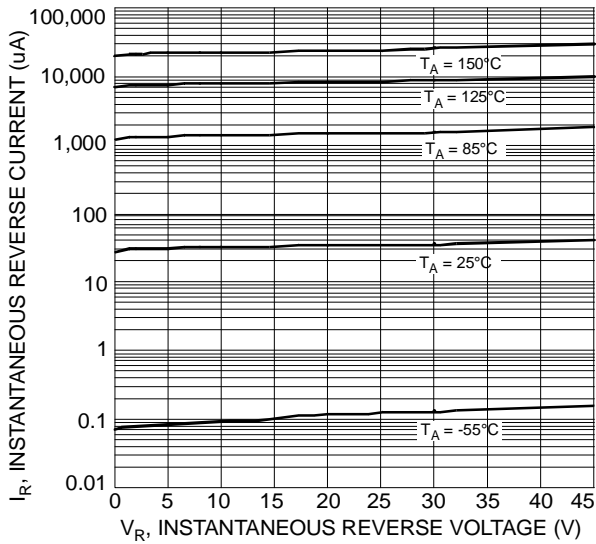

Fig. 3 Typical Reverse Characteristics

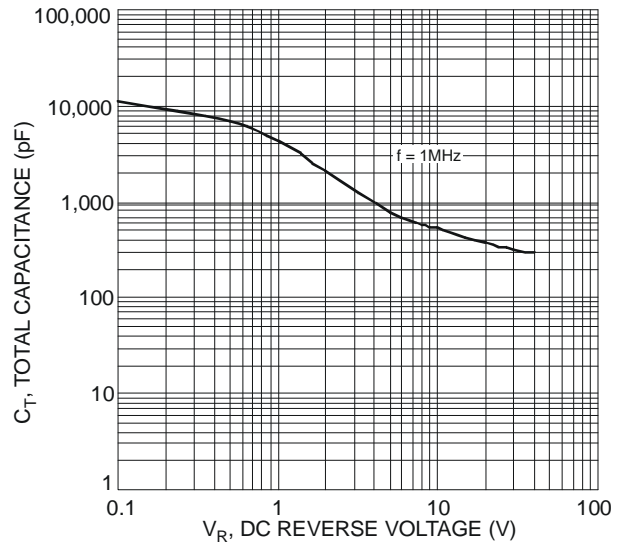

Fig. 4 Total Capacitance vs. Reverse Voltage

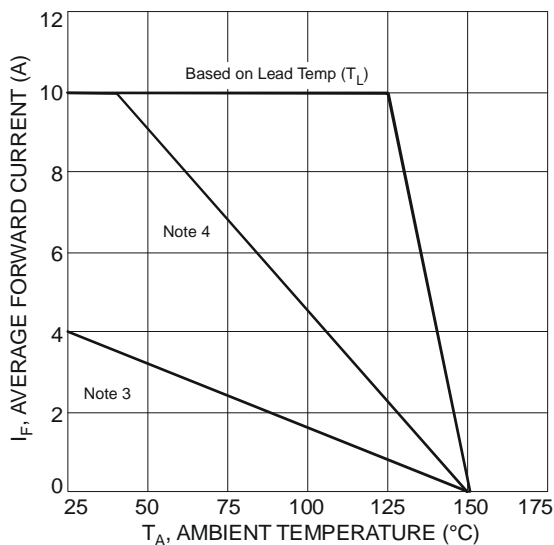

Fig. 5 Forward Current Derating Curve

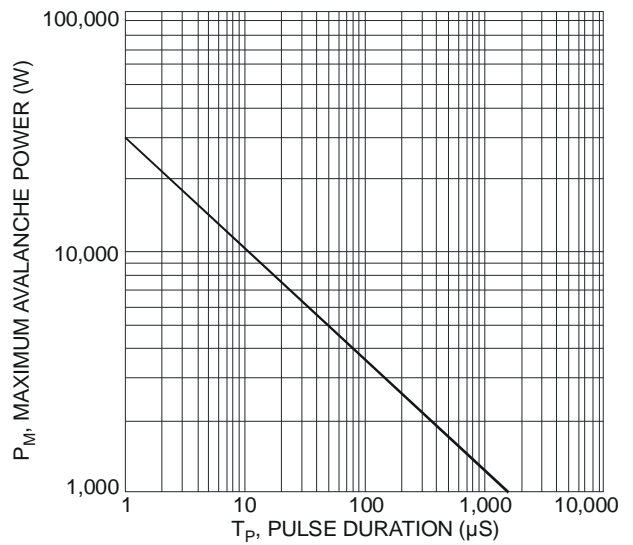

Fig. 6 Maximum Avalanche Power

The curve graph is for reference only, can't be the basis for judgment(曲线图仅供参考!)

